



**Installation Instructions for:
EMS P/N 30-6310
1995-1999 Mitsubishi Eclipse GS-T,
GS-X, Eagle Talon Tsi
2003-2005 Mitsubishi Lancer Evo VIII**

WARNING:



This installation is not for the tuning novice nor the PC illiterate! Use this system with EXTREME caution! The AEM EMS System allows for total flexibility in engine tuning. Misuse of this product can destroy your engine! If you are not well versed in engine dynamics and the tuning of management systems or are not PC literate, please do not attempt the installation. Refer the installation to a AEM trained tuning shop or call 800-423-0046 for technical assistance. You should also visit the AEM EMS Tech Forum at <http://www.aempower.com>

NOTE: AEM holds no responsibility for any engine damage that results from the misuse of this product!

This product is legal in California for racing vehicles only and should never be used on public highways.

Note: Part number 30-6310 supercedes and replaces both 30-1310 and 30-1313. Due to pinout function differences including fuel pump, A/C control and fan control, the calibration from a 2G Eclipse/Talon cannot be used for an EVO8 (and vice versa).

Vehicle	Series I EMS	Series II EMS
1995 – 1999 Mitsubishi Eclipse Turbo / Dodge Talon Tsi	30-1310	30-6310
2003 – 2005 Mitsubishi Lancer Evolution VIII	30-1313	30-6310

ADVANCED ENGINE MANAGEMENT INC.
2205 126th Street Unit A Hawthorne, CA. 90250
Phone: (310) 484-2322 Fax: (310) 484-0152
<http://www.aempower.com>
Instruction Part Number: 10-6310
© 2010 Advanced Engine Management, Inc.

Thank you for purchasing an AEM Engine Management System.

The AEM Engine Management System (EMS) is the result of extensive development on a wide variety of cars. Each system is engineered for the particular application. The AEM EMS differs from all others in several ways. The EMS is a stand alone system, which completely replaces the factory ECU and features unique Plug and Play Technology, which means that each system is configured especially for your make and model of car without any jumper harnesses. There is no need to modify your factory wiring harness and in most cases your car may be returned to stock in a matter of minutes.

For stock and slightly modified vehicles, the supplied startup calibrations are configured to work with OEM sensors, providing a solid starting point for beginner tuning. For more heavily modified cars, the EMS can be reconfigured to utilize aftermarket sensors and has many spare inputs and outputs allowing the elimination of add-on rev-limiters, boost controllers, nitrous controllers, fuel computers, etc. It also includes a configurable onboard 1MB data logger that can record any 16 EMS parameters at up to 250 samples per second. Every EMS comes with all functions installed and activated; there is no need to purchase options or upgrades to unlock the full potential of your unit.

The installation of the AEM EMS on the supported vehicles uses the stock sensors and actuators. After installing the AEMTuner software, the startup calibration will be saved to the following folder on your PC:

C:\Program Files\AEM\AEMTuner\Calibrations\Mitsubishi-DSM

Multiple calibrations may be supplied for each EMS; additional details of the test vehicle used to generate each calibration can be found in the Calibration Notes section for that file.

Please visit the AEM Performance Electronics Forum at <http://www.aempower.com> and register. We always post the most current strategy release, PC Software and startup calibrations online. On the forum, you can find and share many helpful hints/tips to make your EMS perform its best.

TUNING NOTES AND WARNING:

While the supplied startup calibration may be a good starting point and can save considerable time and money, it will not replace the need to tune the EMS for your specific application. AEM startup calibrations are not intended to be driven aggressively before tuning. We strongly recommend that every EMS be tuned by someone who is already familiar with the AEM software and has successfully tuned vehicles using an AEM EMS. Most people make mistakes as part of the learning process; be warned that using your vehicle as a learning platform can damage your engine, your vehicle, and your EMS.

Read and understand these instructions **BEFORE** attempting to install this product.

1) Install AEMTuner software onto your PC

The latest version of the AEMTuner software can be downloaded from the AEMTuner section of the AEM Performance Electronics forums. Series 2 units are not supported by the older AEMPro tuning software.

2) Remove the Stock Engine Control Unit

- a) Access the stock Engine Control Unit (ECU). The location of the ECU on the 2G DSM vehicles is behind the radio in the center console. The EVO8 ECU is located behind the glove box.
- b) Carefully disconnect the wiring harness from the ECU. Avoid excessive stress or pulling on the wires, as this may damage the wiring harness. Some factory ECUs use a bolt to retain the factory connectors, and it must be removed before the harness can be disconnected. There may be more than one connector, and they must all be removed without damage to work properly with the AEM ECU. Do not cut any of the wires in the factory wiring harness to remove them.
- c) Remove the fasteners securing the ECU to the car body, and set them aside. Do not destroy or discard the factory ECU, as it can be reinstalled easily for street use and troubleshooting.

3) Install the AEM Engine Management System

- a) Plug the factory wiring harness into the AEM EMS and position it so the wires are not pulled tight or stressed in any manner. Secure the EMS with the provided Velcro fasteners.
- b) Plug the communications cable into the EMS and into your PC.
- c) Turn the ignition on but do not attempt to start the engine.
- d) The USB drivers must be installed the first time you connect to a Series 2 EMS with an onboard USB port. When the Series 2 EMS is connected to the PC's USB port and receiving power from the vehicle, the "Found New Hardware" window will appear. Select "Install from a list of specific location (Advanced)" and browse to the following folder: *C:\Program Files\AEM\AEMTuner\USB Drivers (Series 2)*

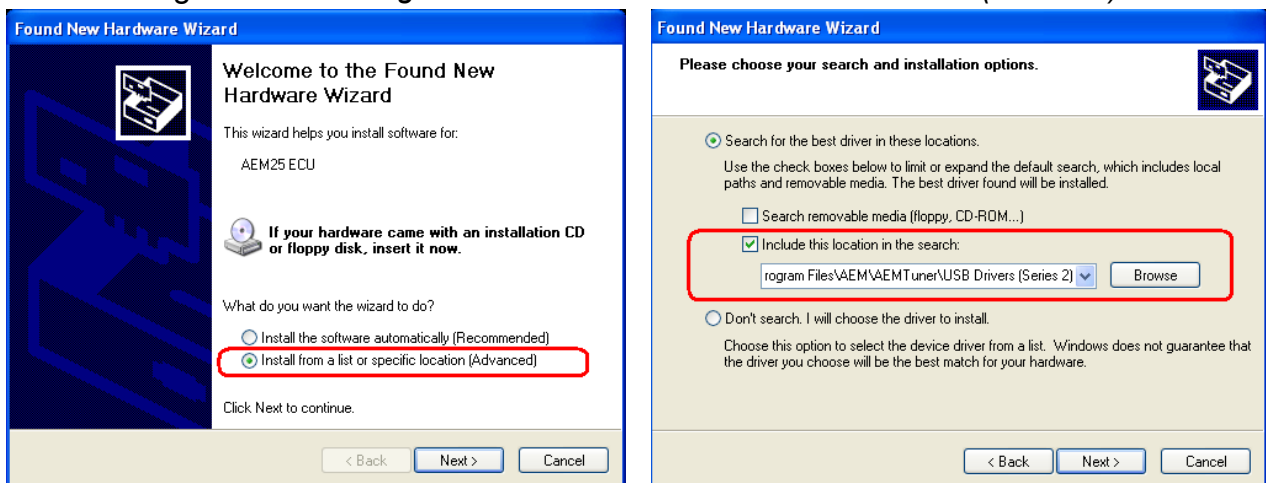

- e) With the AEMTuner software open, select **ECU>>Upload Calibration** to upload the startup calibration file (.cal) that most closely matches the vehicle's configuration to be tuned. Check the Notes section of the calibration for more info about the vehicle it was configured for. These files can be found in the following folder:
C:\Program Files\AEM\AEMTuner\Calibrations\Mitsubishi-DSM

- f) Set the throttle range: Select Wizards>>Set Throttle Range and follow the on-screen instructions. When finished, check that the 'Throttle' channel never indicates less than 0.2% or greater than 99.8%, this is considered a sensor error and may cause some functions including idle feedback and acceleration fuel to operate incorrectly.

4) Ready to begin tuning the vehicle.

- a) Before starting the engine, verify that the fuel pump runs for a couple of seconds when the key is turned on and there is sufficient pressure at the fuel rail. If a MAP sensor is installed, check that the Engine Load indicates something near atmospheric pressure (approximately 101kPa or 0 PSI at sea level) with the key on and engine off. Press the throttle and verify that the 'Throttle' channel responds but the Engine Load channel continues to measure atmospheric pressure correctly.
- b) Start the engine and make whatever adjustments may be needed to sustain a safe and reasonably smooth idle. Verify the ignition timing: Select **Wizards>>Ignition Timing Sync** from the pull-down menu. Click the '*Lock Ignition Timing*' checkbox and set the timing to a safe and convenient value (for instance, 10 degrees BTDC). Use a Timing Light and compare the physical timing numbers to the timing value you selected. Use the *Sync Adjustment Increase/Decrease* buttons to make the physical reading match the timing number you selected.
- c) Note: This calibration needs to be properly tuned before driving the vehicle. It is intended for racing vehicles and may not operate smoothly at idle or part-throttle.
NEVER TUNE THE VEHICLE WHILE DRIVING

5) Troubleshooting an engine that will not start

- a) Double-check all the basics first... engines need air, fuel, compression, and a correctly-timed spark event. If any of these are lacking, we suggest checking simple things first. Depending on the symptoms, it may be best to inspect fuses, sufficient battery voltage, properly mated wiring connectors, spark using a timing light or by removing the spark plug, wiring continuity tests, measure ECU pinout voltages, replace recently-added or untested components with known-good spares. Check that all EMS sensor inputs measure realistic temperature and/or pressure values.
- b) If the EMS is not firing the coils or injectors at all, open the Start tab and look for the 'Stat Sync'd' channel to turn ON when cranking. This indicates that the EMS has detected the expected cam and crank signals; if Stat Sync'd does not turn on, monitor the Crank Tooth Period and T2PER channels which indicate the time between pulses on the Crank and T2 (Cam) signals. Both of these channels should respond when the engine is cranking, if either signal is not being detected or measuring an incorrect number of pulses per engine cycle the EMS will not fire the coils or injectors.
- c) If the Engine Load changes when the throttle is pressed this usually indicates that there is a problem with the MAP sensor wiring or software calibration (when the EMS detects that the MAP Volts are above or below the min/max limits it will run in a failsafe mode using the TPS-to-Load table to generate an artificial Engine Load signal using the Throttle input). This may allow the engine to sputter or start but not continue running properly.

Application Notes for EMS P/N 30-6310

1995-1999 Eclipse Turbo / Eagle Talon Tsi

2003-2005 Lancer Evolution VIII

Make:	Mitsubishi/Dodge
Model:	Eclipse Turbo / Talon Tsi / EVO VIII
Years Covered:	1995 – 1999 Eclipse Turbo / Talon, 2003-2005 EVO8
Engine Displacement:	2.0L
Engine Configuration:	I4
Firing Order:	1-3-4-2
N/A, S/C or T/C:	Turbocharged
Load Sensor Type:	Karman Vortex MAF
# Coils:	2 (wasted spark)
Ignition driver type:	0-5V, Falling Edge trigger
# Injectors:	4 (P&H drivers: Inj1-4)
Injector Flow Rate:	450 cc/min
Injector Resistance:	2.5 Ω
Factory Inj Resistors:	Yes (6 Ω)
Injection Mode:	Sequential
Knock Sensors used:	1
Lambda Sensors used:	1 (aftermarket wideband: factory O2 not supported)
Idle Motor Type:	Stepper
Main Relay Control:	Yes (Switch1 in, Coil7 out)
Crank Pickup Type:	Hall
Crank Teeth/Cycle:	4
Cam Pickup Type:	Hall
Cam Teeth/Cycle:	2
Transmissions Offered:	M/T, A/T
Trans Supported:	M/T Only
Drive Options:	FWD, AWD
Supplied Connectors:	Connector B, spare pins
Plug-N-Pin kit:	AEM part# 35-2611 (includes plugs A-D, pins)

Spare Injector Drivers:	Inj 7, Pin 116
Spare Injector Drivers:	Inj 8, Pin 6
Spare Injector Drivers:	Inj 9, Pin 83
Spare Injector Drivers:	Inj 10, Pin 105
Spare Injector Drivers:	Inj 11, Pin 89
Spare Injector Drivers:	Inj 12, Pin 104
Spare Coil Drivers:	Coil 4, Pin 91
Spare Coil Drivers:	Coil 5, Pin 82
Spare Coil Drivers:	Coil 6, Pin 85
Boost Solenoid:	PW 2, Pin 102
EGT 1 Location:	Pin 54
EGT 2 Location:	Pin 90
EGT 3 Location:	Pin 112
EGT 4 Location:	Pin 111
Spare 0-5V Channels:	MAF, Pin 59
Spare 0-5V Channels:	ADCR12, Pin 65
Spare Low Side Driver:	Low Side 1, Pin 109
Spare Low Side Driver:	Low Side 2, Pin 21
Spare Low Side Driver:	Low Side 3, Pin 71
Spare Low Side Driver:	Low Side 4, Pin 9
Spare Low Side Driver:	Low Side 5, Pin 90
Spare Low Side Driver:	Low Side 9, Pin 20
Check Engine Light:	Low Side 10, Pin 106
Spare Switch Input:	Switch 3, Pin 24
Spare Switch Input:	Switch 4, Pin 7
Spare Switch Input:	Switch 5, Pin 107
Spare Switch Input:	Switch 6, Pin 114
A/C Switch Input:	Switch 2, Pin 115
Clutch Switch Input:	---

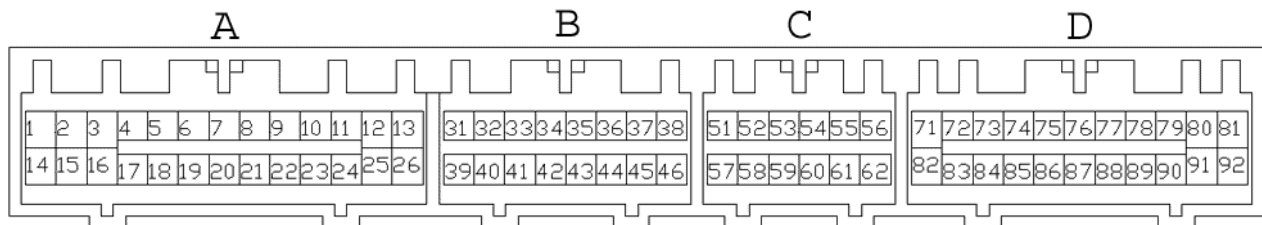

35-6310 AS VIEWED FROM END OF EMS

WARNING:

* The factory A/C request switch sends 12V power to signal an A/C request and the 30-6310 EMS has been designed to accept 12V power on this switched input. If users desire to re-wire a new switch to trigger the Switch 2 input the switch should connect to 12V power when the switch is on. The pin can be left floating (disconnected) when the switch is off; it is not required to send ground to this pin.

****All other switch input pins must connect to ground; the switch should not provide 12V power to the EMS because that will not be detected as on or off. Connecting 12V power to the Switch 3, Switch 4 or Switch 5 pins may damage your EMS and void your warranty.**

Wiring harness destinations for non-USDM vehicles may be different than listed in the pinout charts below. If installing this EMS on a vehicle not originally sold in the US, please verify that the vehicle's wiring harness matches the pinout shown here before installation.

The function of several pins have been changed from the original 30-1310 EMS, please see the pinout chart for more info.

Primary Load Sensor, EMS Fuel Strategy

The factory MAF (mass air flow) sensor can be removed to help decrease intake air restriction; the EMS can be configured to use a MAP sensor to determine engine load. It is recommended to use a 3.5 bar MAP sensor or higher (P/N 30-2130-50). Please be aware that the IAT (intake air temperature) sensor is integrated into the factory MAF sensor. If the factory MAF / IAT sensor is removed, you may wish to install an AEM IAT Sensor Kit (P/N 30-2010), which includes a sensor, wire connector, and aluminum weld-in bung. While the factory MAF sensor locates the IAT sensor upstream of the turbocharger inlet, it may be preferable to install an IAT sensor downstream of the intercooler to accurately measure charge temperatures.

The factory Mass Air Flow and Intake Air Temperature sensors can be used as the primary load input for the AEM EMS if desired. Please check the Notes section of each calibration for more info about the vehicle setup and fuel strategy that calibration was configured to use.

EMS Fuel Map, Boost Fuel Trim Table

The 30-6310 maps provided utilize the "*Boost Fuel Trim Table*" to provide a 1:1 fuel compensation above and below atmospheric pressure. In the startup calibration, the "*Boost Fuel Trim Table*" is configured to provide twice as much fuel when the manifold pressure is twice as high and half the fuel when the manifold pressure is half as high; this should help simplify the tuning process for different vacuum and boost levels. Notice the values in the main "*Fuel Map*" do not change above 100 kPa (0 psi boost), the fuel correction is being made by the "*Boost Fuel Trim Table*."

Note: the "*Boost Fuel Trim Table*" must be adjusted if a different MAP sensor is installed or if the Load breakpoints are adjusted. The Boost Fuel Trim value should be set to -90 at 10kPa, 0 at 100 kPa, +100 at 200 kPa, +200 at 300 kPa, etc...

Peak and Hold Injector Drivers

Injectors 1-6 include Peak (4 amps) and Hold (1 amp) injector drivers. These drivers may be used with peak and hold or saturated type injectors. The factory Mitsubishi wiring harness contains a resistor pack to prevent excessive current when using low-impedance injectors with the stock ECU. With the 30-6310 installed, users can elect to remove and bypass the OEM resistor pack for more precise control of low-impedance injectors.

Please note that the injector response time will be different with and without the factory injector resistor pack. If the OEM resistor pack has been removed and bypassed, please use the correct battery offset wizard for your injectors. Most battery offset wizards will specify <P&H DRIVER> if they are intended for use without a resistor pack.

Unused accessories:

The check engine light (LS10 output) is configured as a shift light at 7000 RPM but this value can be changed.

The stock “boost” gauge is not used on 2G DSM vehicles.

Major pinout differences, 2G DSM vs EVO8:

Fuel Pump: LS11 output (pin 8) for 2G DSM, LS6 output (pin 22) for EVO8.

A/C relay: LS6 output (pin 22) for 2G DSM, LS11 output (pin 8) for EVO8.

Fuel Pump Control

There is a main Fuel Pump Relay (LS6 output for the EVO8, LS11 output for the 2G DSM) which is used to turn the pump on or off.

The INJ5 output (pin 3) controls the Fuel Pressure Solenoid on both the EVO8 and 2G DSM. The Fuel Pressure Solenoid causes the Fuel Pressure Regulator’s vacuum line to reference atmospheric pressure rather than the intake manifold pressure. This will allow for increased fuel pressure in vacuum, but the lack of pressure reference will lead to insufficient fuel pressure when manifold pressure is above atmospheric pressure. This output is always disabled in the start-up calibration.

The LS1 output (pin 39) controls the Fuel Pump Low Speed Relay, which is only present on the EVO8. This relay can be activated to decrease voltage sent to the fuel pump. This output is always disabled in the start-up calibration.

WARNING: Reducing the voltage sent to the fuel pump can affect fuel pump output (volume and/or pressure). If you wish to decrease fuel pump speed, monitor fuel pressure and air/fuel ratio very carefully to avoid engine damage!

EVO8 Fan Control:

The EVO8 has two fans: the A/C Condenser fan and the Radiator fan.

The A/C Condenser fan is mounted in front of the A/C condenser (near front bumper opening). There are two control relays in the factory wiring harness that can change the speed of the A/C condenser fan. When the INJ12 output (pin 34) is ON but the IDLE5 output (pin 32) is OFF, the fan will run at low speed. When both the INJ12 (pin 34) and IDLE5 (pin 32) are ON, the fan will run at high speed. Note that the A/C condenser fan will also force air through the radiator.

The Cooling Fan is mounted behind the radiator (near the turbocharger). There is a Fan Control Module that can change the speed of the Cooling Fan. The LS2 output (pin 21) of the EMS sends a pulse-width modulated signal of various duty cycles to the Fan Control Module to request various fan speeds. The start-up calibration uses User PW table to control the duty cycle of the LS2 output. The 'User PW Analog In' option will define the x-axis of the table; this is set to Coolant Volts in the start-up calibration.

Please use the following reference chart when making adjustments to the User PW table:

Temp (deg C)	Temp (deg F)	User 1 in (Coolant Volts %)	Notes
127	261	0.0	90% duty cycle (high fan speed)
127	261	6.3	90% duty cycle (high fan speed)
127	261	12.5	90% duty cycle (high fan speed)
109	228	18.8	90% duty cycle (high fan speed)
92	198	25.0	60% duty cycle (med fan speed)
79	172	31.3	10% duty cycle (low fan speed)
68	154	37.5	0% duty cycle (fan off)
60	140	43.8	0% duty cycle (fan off)
53	127	50.0	0% duty cycle (fan off)
46	115	56.3	0% duty cycle (fan off)
39	102	62.5	0% duty cycle (fan off)
33	91	68.8	0% duty cycle (fan off)
25	77	75.0	0% duty cycle (fan off)
14	57	81.3	0% duty cycle (fan off)
2	36	87.5	0% duty cycle (fan off)
-14	7	93.8	0% duty cycle (fan off)
-33	-27	100.0	0% duty cycle (fan off)

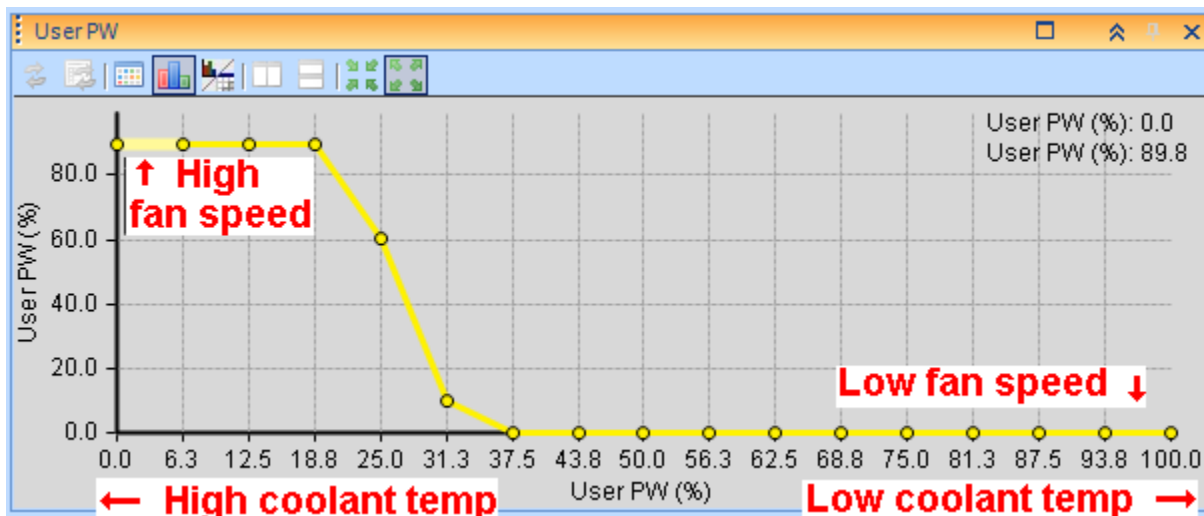

Wiring accessories to the EMS:

Please follow this suggested wiring diagram when adding accessories such as UEGO gauges, MAP sensors, IAT sensors, or switches for use with the EMS. Note that wire polarity is not important for the Air Temperature sensor.

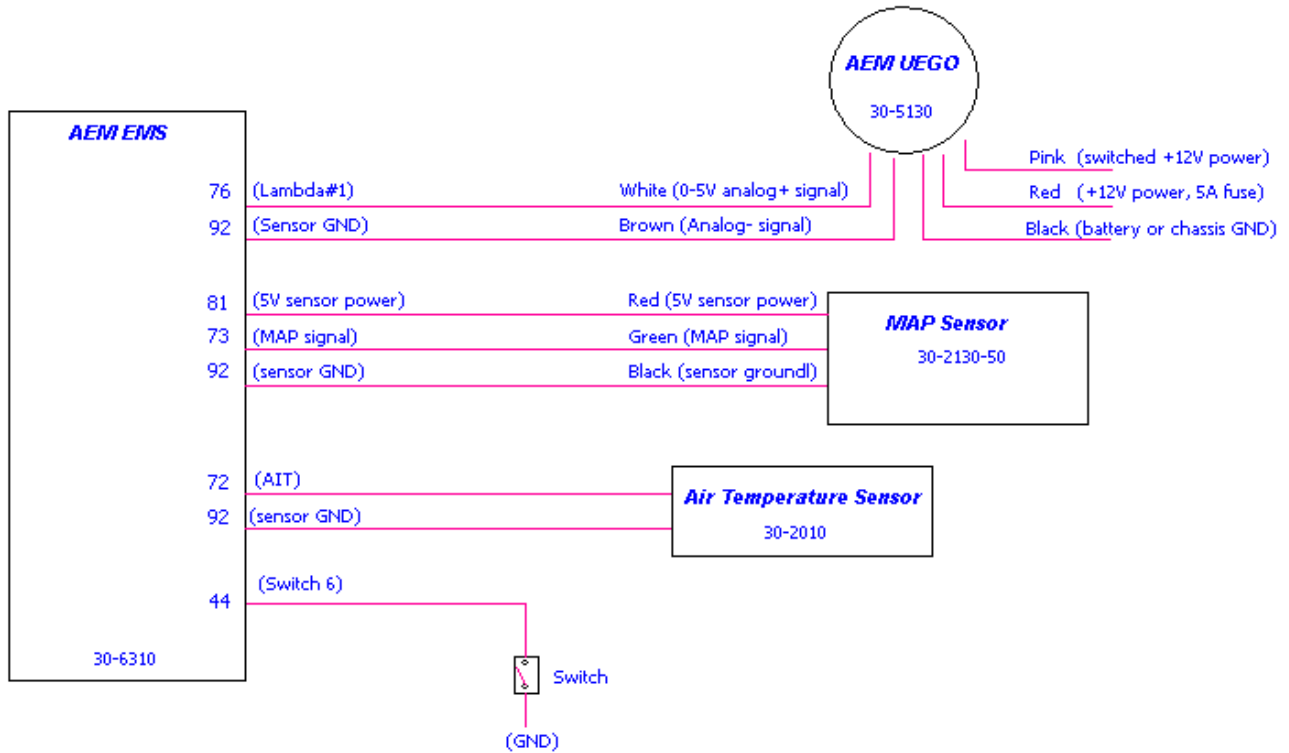

Connection Diagram for EMS P/N 30-6310

PnP	Means the Plug and Play system comes with this configured for proper operation of this device. Is still available for reassignment by the end user.
Avail	Means the function is not currently allocated and is available for use
Dedicated	Means the location is fixed and cant be changed

Pin	95 - 99 Eclipse Turbo / Talon Tsi	2003-2005 Evo VIII	AEM EMS 30-6310	I/O	95 - 99 Eclipse/Talon Notes	2003-2005 Evo VIII Notes
1	Injector 1	<--	Injector 1 P&H	Output	Injector 1 (Peak/Hold 4A/1A driver)	<--
2	Injector 3	<--	Injector 3 P&H	Output	Injector 3 (Peak/Hold 4A/1A driver)	<--
3	Fuel Pressure Solenoid	<--	Injector 5 P&H	Output	Injector 5 (Peak/Hold 4A/1A driver)	<--
4	Idle Speed Control Servo (pin 1)	Idle Speed Control Servo (A1)	Idle 1	Output	PnP for Stepper Idle Motor	<--
5	Idle Speed Control Servo (pin 4)	Idle Speed Control Servo (B1)	Idle 3	Output	PnP for Stepper Idle Motor	<--
6	EGR Solenoid Valve	<--	Injector 8	Output	Avail, Inj output 1.5A max (not P&H)	<--
7	---	---	Not Used	---	---	---
8	MFI Relay (fuel pump)	Magnetic Clutch Relay	Low Side 11	Output	PnP for Fuel Pump relay	PnP for A/C Compressor Relay
9	EVAP Purge Solenoid Valve	<--	Low Side 4	Output	Avail, Switched Ground, 1.5A max	<--
10	Ignition Power Transistor (1&4)	<--	Coil 1	Output	PnP for Coil 1, rising edge trigger	<--
11	Wastegate Solenoid Valve	<--	PW 2	Output	PnP for Wastegate Control Solenoid	<--
12	MFI Relay Power IN (main)	<--	+12V Switched	Input	Dedicated, +12V when relay is on	<--
13	Ground	<--	Ground	Input	Dedicated	<--
14	Injector 2	<--	Injector 2 P&H	Output	Injector 2 (Peak/Hold 4A/1A driver)	<--
15	Injector 4	<--	Injector 4 P&H	Output	Injector 4 (Peak/Hold 4A/1A driver)	<--
16	Boost Gauge	---	Injector 6 P&H	Output	Available, Injector 6 (Peak/Hold 4A/1A driver)	<--
17	Idle Speed Control Servo (pin 3)	Idle Speed Control Servo (A2)	Idle 2	Output	PnP for Stepper Idle Motor	<--
18	Idle Speed Control Servo (pin 6)	Idle Speed Control Servo (B2)	Idle 4	Output	PnP for Stepper Idle Motor	<--
19	MAF reset switch	<--	Low Side 8	Output	Avail, Switched Ground, 1.5A max	<--
20	Radiator/Condensor Fan Relay HI, LO2	---	Low Side 9	Output	PnP for Fan Control	Avail, Switched Ground, 1.5A max
21	Radiator Fan Relay LO1	Cooling Fan Control signal	Low Side 2	Output	Avail, Switched Ground, 1.5A max	PnP, User 1 PW output (coolant)
22	Magnetic Clutch Relay	MFI Relay (Fuel Pump)	Low Side 6	Output	PnP for A/C Compressor	PnP for Fuel Pump relay
23	Ignition Power Transistor (2&4)	<--	Coil 2	Output	PnP for Coil 2, rising edge trigger	<--
24	---	<--	Switch 3	Input	Avail, switch must connect to ground	<--
25	MFI Relay Switched Power	<--	+12V Switched	Input	Dedicated, +12V when relay is on	<--
26	Ground	<--	Ground	Input	Dedicated	<--

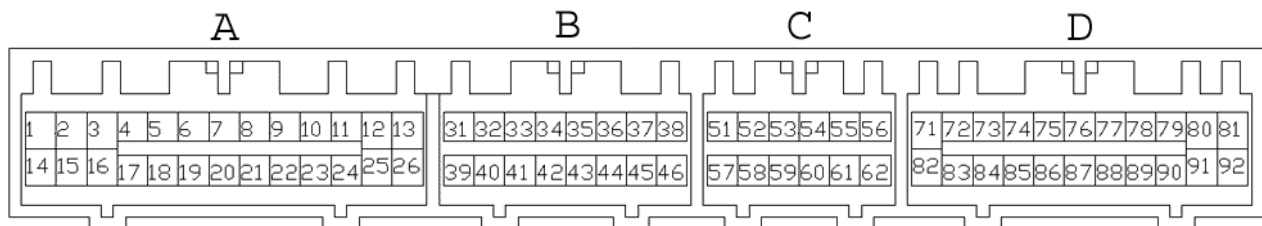

35-6310 AS VIEWED FROM END OF EMS

Connection Diagram for EMS P/N 30-6310

PnP
Avail
Dedicated

Means the Plug and Play system comes with this configured for proper operation of this device. Is still available for reassignment by the end user.

Means the function is not currently allocated and is available for use

Means the location is fixed and cant be changed

Pin	95 - 99 Eclipse Turbo / Talon Tsi	2003-2005 Evo VIII	AEM EMS 30-6310	I/O	95 - 99 Eclipse/Talon Notes	2003-2005 Evo VIII Notes
31	---	<--	Idle 8	Output	Avail, Ground / +12V, 1.5A max	<--
32	---	Condenser Fan Relay (HIGH)	Idle 5	Output	Avail, Ground / +12V, 1.5A max	PnP for Fan Control
33	Voltage Regulator G	<--	Not Used	---	---	---
34	---	Condenser Fan Relay (LOW)	Injector 12	Output	Avail, Inj output 1.5A max (not P&H)	PnP for Fan Control
35	---	H2O Spray LED	Injector 10	Output	Avail, Inj output 1.5A max (not P&H)	PnP for H2O Spray
36	Check Engine Light	Lamp: "Service Engine Soon"	Low Side 10	Output	PnP for 7,000 RPM Shift Light	<--
37	PS Press. Switch	<--	Switch 5	Input	Avail, switch must connect to ground	<--
38	MFI Relay	<--	Main Relay (Coil7)	Output	Dedicated, EMS activates relay with switched GND	<--
39	---	Fuel Pump Low Speed Relay	Low Side 1	Output	Avail, Switched Ground driver	PnP for Fuel Pump Low Speed Relay
40	---	MAF Ground	Sensor Ground	Output	Dedicated, sensors only	Dedicated, sensors only
41	Voltage Regulator FR	<--	EGT4 (ADCR16)	Input	Avail, jumper set for 0-5V Input	<--
42	---	<--	EGT3 (ADCR15)	Input	Avail, jumper set for 0-5V Input	<--
43	---	Clutch Pedal Sw	Switch 4	Input	Avail, switch must connect to ground	PnP for Clutch switch
44	---	H2O Spray Auto Switch	Switch 6	Input	Avail, switch must connect to ground	PnP for H2O Spray
45	Automatic Compressor ECM	<--	Switch 2	Input	PnP for A/C request switch	<--
46	---	<--	Injector 7	Output	Avail, Inj output 1.5A max (not P&H)	<--

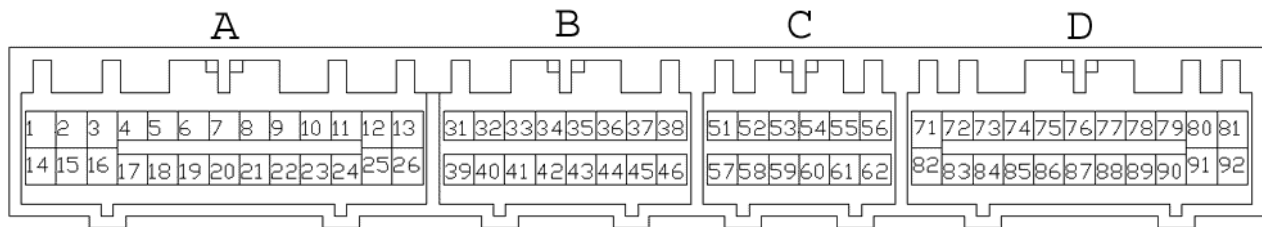

35-6310 AS VIEWED FROM END OF EMS

Connection Diagram for EMS P/N 30-6310

PnP
Avail
Dedicated

Means the Plug and Play system comes with this configured for proper operation of this device. Is still available for reassignment by the end user.

Means the function is not currently allocated and is available for use

Means the location is fixed and cant be changed

Pin	95 - 99 Eclipse Turbo / Talon Tsi	2003-2005 Evo VIII	AEM EMS 30-6310	I/O	95 - 99 Eclipse/Talon Notes	2003-2005 Evo VIII Notes
51	---	Immobilizer System	Low Side 3	Output	Avail, Switched Ground driver	<--
52	Ignition Timing Adj. Connector	---	Coil 3	Output	Avail, Switched Ground, 1.5A max	Avail, Switched Ground, 1.5A max
53	---	<--	Coil 5	Output	Avail, Switched Ground, 1.5A max	<--
54	O2 Heater Rear	<--	Injector 9	Output	Avail, Switched Ground, 1.5A max	<--
55	Evap. Vent Solenoid Valve (99 Only)	Evap. Vent Solenoid Valve	Low Side 5	Output	Avail, Inj output 1.5A max (not P&H)	<--
56	Data Link Connector	---	Coil 6	Output	Avail, Switched Ground, 1.5A max	<--
57	---	H2O Spray Relay	Idle 7	Output	Avail, Ground / +12V, 1.5A max	PnP for H2O Spray
58	Tacho	<--	Low Side 7	Output	PnP for Tacho	PnP for Tacho
59	---	<--	Low Side 12	Output	Avail, Switched Ground driver	←
60	O2 Heater Front	<--	Injector 11	Output	Avail, Switched Ground, 1.5A max	<--
61	Fuel Tank Differ. Pressure Sensor (99 Only)	Fuel Tank Differ. Pressure Sensor	EGT2	Input	Avail, Inj output 1.5A max (not P&H)	<--
62	Data Link Connector	<--	Coil 4	Output	Avail, jumper set for 0-5V Input	<--

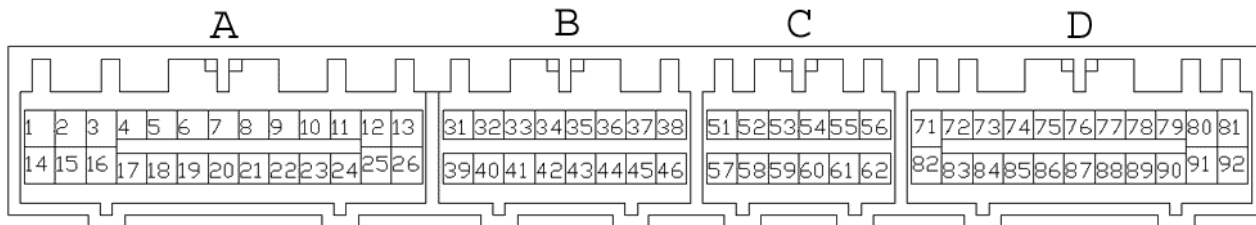

35-6310 AS VIEWED FROM END OF EMS

Connection Diagram for EMS P/N 30-6310

PnP
Avail
Dedicated

Means the Plug and Play system comes with this configured for proper operation of this device. Is still available for reassignment by the end user.

Means the function is not currently allocated and is available for use

Means the location is fixed and cant be changed

Pin	95 - 99 Eclipse Turbo / Talon Tsi	2003-2005 Evo VIII	AEM EMS 30-6310	I/O	95 - 99 Eclipse/Talon Notes	2003-2005 Evo VIII Notes
71	Starter Signal	<--	Main Relay (Start sw)	Input	Dedicated, activates Switch 1 input	<--
72	Intake Air Temp Sensor	<--	AIT	Input	Dedicated, 2.2k ohm pull-up to 5V	<--
73	Manifold Differential Press. Sensor	<--	MAP	Input	Avail, 0-5V MAP sensor input	<--
74	---	Fuel Level In	EGT #1	Input	Avail, jumper set for 0-5V Input	<--
75	O2 Sensor Rear	<--	O2 #2	Input	Dedicated, 0-5V signal	<--
76	O2 Sensor Front	<--	O2 #1	Input	Dedicated, 0-5V signal	<--
77	---	Fuel Temperature	CAN1L	---	Dedicated	<--
78	Knock Sensor	<--	Knock #1	Input	Dedicated, software knock filter	<--
79	---	Data Link Connector	MAF	Input	Available, 0-5V sensor input	<--
80	Battery Back Up	<--	Permanent +12V	Input	Dedicated, used to store internal log	<--
81	5V sensor supply	<--	+5V Sensor	Output	Dedicated, sensors only	<--
82	Ignition Switch	<--	Main Relay (Ign sw)	Input	Dedicated, activates Switch 1 input	<--
83	Engine Coolant Temp. Sensor	<--	Coolant	Input	Dedicated, 750 ohm pull-up to 5V	<--
84	Throttle Position Switch	<--	TPS	Input	Dedicated, 100k ohm pull-up to 5V	<--
85	Atmospheric Pressure Sensor	<--	Baro Volts	Input	Available, 0-5V sensor input	<--
86	Vehicle Speed Sensor	<--	T3 (Vehicle Speed)	Input	PnP for Vehicle Speed Sensor	<--
87	Throttle Position Switch	---	CAN1H	---	Dedicated	<--
88	Camshaft Position Sensor	<--	Cam	Input	Dedicated, Camshaft sensor	<--
89	Crankshaft Position Sensor	<--	Crank	Input	Dedicated, Crankshaft sensor	<--
90	Volume Air Flow Sensor	<--	T4 (Spare Speed)	Input	PnP for frequency MAF input	<--
91	---	H2O Spray Manual Sw	Ground	Output	Dedicated	<--
92	Sensor Ground	<--	Sensor Ground	Output	Dedicated, sensors only	<--

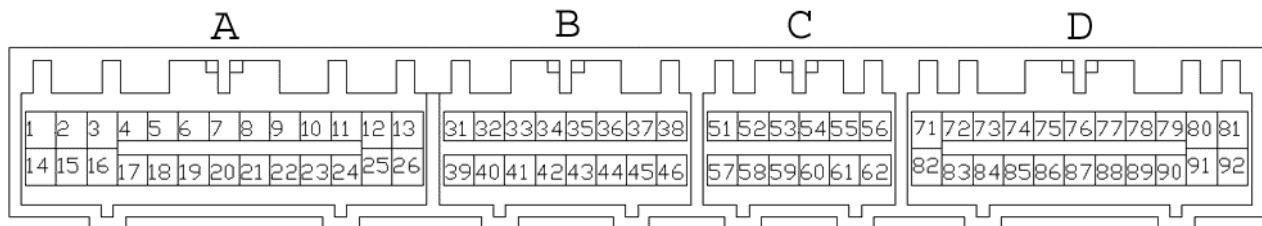

35-6310 AS VIEWED FROM END OF EMS

30-1310 (Series 1) vs 30-6310 (Series 2 EMS differences:

The EMS functions assigned to certain pins have been changed and no longer match the 30-1310 EMS. Unless otherwise noted, the following pins and functions will need to be manually reconfigured after using AEMTuner to convert a V1.19 (30-1310, Series 1 EMS) calibration for use with the 30-6310 Series 2 hardware.

Pin	95-99 Eclipse Turbo / Talon Tsi	2003-2005 Evo VIII	30-1310 function	30-6310 function	Notes
7	---	---	Switch 4	N/C	Pin has no internal connection, Switch 4 available on pin 43
32	---	Condenser Fan control (HI)	PW 2	Idle 5	30-1313 used Idle5 also
34	Timing Adj. / LF O2 heater		Injector #10	Injector 12	Inj10 available on pin 35
38	MFI Relay control	MFI Relay control	Coil 5	Coil 7	Use Coil 7 settings from 6310 startup calibration
43	---	Clutch Pedal Sw	HS4	Switch 4	HS4 not available
44	---		EGT 2	Switch 6	EGT 2 available on pin 61
52	---		PW #1i	Coil 3	connects to pin 11
53	---		Switch 6	Coil 5	Switch 6 available on pin 44
56	---		High Side #3	Coil 6	HS3 not available
57	---	H2O spray relay	HS1	Idle 7	30-1313 used Idle7 also
60	O2 Heater Front	O2 Heater Front	Injector #9	Injector 11	Inj 9 available on pin 83 (54)
61	Fuel Tank Diff. Press. sensor	Fuel Tank Diff. Press. sensor	ADCR11	EGT 2	ADCR11 not available
62	Data Link Connector	Data Link Connector	FM	Coil 4	
77	---	Fuel Temperature	Knock #2	CAN1L	Knock #2 not available
87	Throttle Position switch	Throttle Position Switch	ADCR14	CAN1H	ADCR14 not available

AEM Electronics Warranty

Advanced Engine Management Inc. warrants to the consumer that all AEM Electronics products will be free from defects in material and workmanship for a period of twelve months from date of the original purchase. Products that fail within this 12-month warranty period will be repaired or replaced when determined by AEM that the product failed due to defects in material or workmanship. This warranty is limited to the repair or replacement of the AEM part. In no event shall this warranty exceed the original purchase price of the AEM part nor shall AEM be responsible for special, incidental or consequential damages or cost incurred due to the failure of this product. Warranty claims to AEM must be transportation prepaid and accompanied with dated proof of purchase. This warranty applies only to the original purchaser of product and is non-transferable. All implied warranties shall be limited in duration to the said 12-month warranty period. Improper use or installation, accident, abuse, unauthorized repairs or alterations voids this warranty. AEM disclaims any liability for consequential damages due to breach of any written or implied warranty on all products manufactured by AEM. Warranty returns will only be accepted by AEM when accompanied by a valid Return Merchandise Authorization (RMA) number. Product must be received by AEM within 30 days of the date the RMA is issued.

Please note that before AEM can issue an RMA for any electronic product, it is first necessary for the installer or end user to contact the tech line at 1-800-423-0046 to discuss the problem. Most issues can be resolved over the phone. Under no circumstances should a system be returned or a RMA requested before the above process transpires.

AEM will not be responsible for electronic products that are installed incorrectly, installed in a non approved application, misused, or tampered with.

Any AEM electronics product can be returned for repair if it is out of the warranty period. There is a minimum charge of \$75.00 for inspection and diagnosis of AEM electronic parts. Parts used in the repair of AEM electronic components will be extra. AEM will provide an estimate of repairs and receive written or electronic authorization before repairs are made to the product.