



## ***Installation Instructions for: EMS P/N 30-6052***

### ***2000-2005 Honda S2000***



**WARNING:**

This installation is not for the tuning novice nor the PC illiterate! Use this system with **EXTREME** caution! The AEM EMS System allows for total flexibility in engine tuning. Misuse of this product can destroy your engine!

If you are not well versed in engine dynamics and the tuning of management systems or are not PC literate, please do not attempt the installation. Refer the installation to an AEM-trained tuning shop. A list of tuners can be found in the "AEM EMS Tuning" subsection of the AEM Electronics Forums at <http://www.aempower.com> or by calling 800-423-0046.

**NOTE:** AEM holds no responsibility for any engine damage that results from the misuse of this product!

**This product is legal in California for racing vehicles only and should never be used on public highways.**

**ADVANCED ENGINE MANAGEMENT INC.**  
2205 126<sup>th</sup> Street Unit A Hawthorne, CA. 90250  
Phone: (310) 484-2322 Fax: (310) 484-0152  
[Http://www.aempower.com](http://www.aempower.com)  
Instruction Part Number: 10-6050  
© 2009 Advanced Engine Management, Inc.

Thank you for purchasing an AEM Engine Management System.

The AEM Engine Management System (EMS) is the result of extensive development on a wide variety of cars. Each system is engineered for the particular application. The AEM EMS differs from all others in several ways. The EMS is a stand alone system, which completely replaces the factory ECU and features unique Plug and Play Technology, which means that each system is configured especially for your make and model of car without any jumper harnesses. There is no need to modify your factory wiring harness and in most cases your car may be returned to stock in a matter of minutes.

For stock and slightly modified vehicles, the supplied startup calibrations are configured to work with OEM sensors, providing a solid starting point for beginner tuning. For more heavily modified cars, the EMS can be reconfigured to utilize aftermarket sensors and has many spare inputs and outputs allowing the elimination of add-on rev-limiters, boost controllers, nitrous controllers, fuel computers, etc. It also includes a configurable onboard 1MB data logger that can record any 16 EMS parameters at up to 250 samples per second. Every EMS comes with all functions installed and activated; there is no need to purchase options or upgrades to unlock the full potential of your unit.

The installation of the AEM EMS on the supported vehicles uses the stock sensors and actuators. After installing the AEMTuner software, the startup calibration will be saved to the following folder on your PC:

*C:\Program Files\AEM\AEMTuner\Calibrations\Honda-Acura\*

Multiple calibrations may be supplied for each EMS; additional details of the test vehicle used to generate each calibration can be found in the Calibration Notes section for that file.

Please visit the AEM Performance Electronics Forum at <http://www.aempower.com> and register. We always post the most current strategy release, PC Software and startup calibrations online. On the forum, you can find and share many helpful hints/tips to make your EMS perform its best.

### **TUNING NOTES AND WARNING:**

While the supplied startup calibration may be a good starting point and can save considerable time and money, it will not replace the need to tune the EMS for your specific application. AEM startup calibrations are not intended to be driven aggressively before tuning. We strongly recommend that every EMS be tuned by someone who is already familiar with the AEM software and has successfully tuned vehicles using an AEM EMS. Most people make mistakes as part of the learning process; be warned that using your vehicle as a learning platform can damage your engine, your vehicle, and your EMS.

Read and understand these instructions **BEFORE** attempting to install this product.

### 1) Install AEMTuner software onto your PC

The latest version of the AEMTuner software can be downloaded from the AEMTuner section of the AEM Performance Electronics forums. Series 2 units are not supported by the older AEMPro tuning software.

### 2) Remove the Stock Engine Control Unit

- Access the stock Engine Control Unit (ECU). The location of the ECU on the S2000 is behind the driver side kick panel.
- Carefully disconnect the wiring harness from the ECU. Avoid excessive stress or pulling on the wires, as this may damage the wiring harness. Some factory ECUs use a bolt to retain the factory connectors, and it must be removed before the harness can be disconnected. There may be more than one connector, and they must all be removed without damage to work properly with the AEM ECU. Do not cut any of the wires in the factory wiring harness to remove them.
- Remove the fasteners securing the ECU to the car body, and set them aside. Do not destroy or discard the factory ECU, as it can be reinstalled easily for street use and troubleshooting.

### 3) Install the AEM Engine Management System.

- Plug the factory wiring harness into the AEM EMS and position it so the wires are not pulled tight or stressed in any manner. Secure the EMS with the provided Velcro fasteners.
- Plug the comms cable into the EMS and into your PC.
- Turn the ignition on but do not attempt to start the engine.
- The USB drivers must be installed the first time you connect to a Series 2 EMS with an onboard USB port. When the Series 2 EMS is connected to the PC's USB port and receiving power from the vehicle, the "Found New Hardware" window will appear. Select "Install from a list of specific location (Advanced)" and browse to the following folder: *C:\Program Files\AEM\AEMTuner\USB Drivers (Series 2)\*

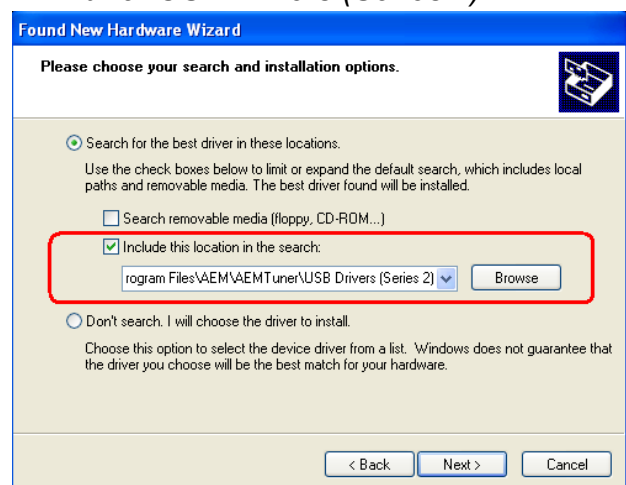
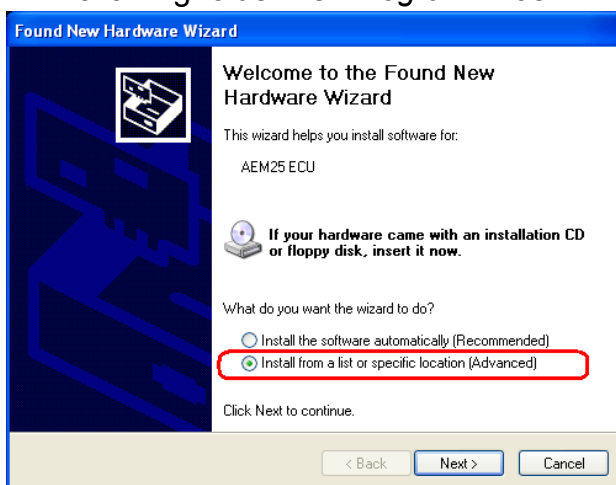

- With the AEMTuner software open, select **ECU>>Upload Calibration** to upload the startup calibration file (.cal) that most closely matches the vehicle's configuration to be tuned. Check the Notes section of the calibration for more info about the vehicle it was configured for. These files can be found in the following folder:  
*C:\Program Files\AEM\AEMTuner\Calibrations\Honda-Acura\*

- f) Set the throttle range: Select Wizards>>Set Throttle Range and follow the on-screen instructions. When finished, check that the 'Throttle' channel never indicates less than 0.2% or greater than 99.8%, this is considered a sensor error and may cause some functions including idle feedback and acceleration fuel to operate incorrectly.

#### 4) Ready to begin tuning the vehicle.

- a) Before starting the engine, verify that the fuel pump runs for a couple of seconds when the key is turned on and there is sufficient pressure at the fuel rail. If a MAP sensor is installed, check that the Engine Load indicates something near atmospheric pressure (approximately 101kPa or 0 PSI at sea level) with the key on and engine off. Press the throttle and verify that the 'Throttle' channel responds but the Engine Load channel continues to measure atmospheric pressure correctly.
- b) Start the engine and make whatever adjustments may be needed to sustain a safe and reasonably smooth idle. Verify the ignition timing: Select **Wizards>>Ignition Timing Sync** from the pull-down menu. Click the '*Lock Ignition Timing*' checkbox and set the timing to a safe and convenient value (for instance, 10 degrees BTDC). Use a timing light and compare the physical timing numbers to the timing value you selected. Use the *Sync Adjustment Increase/Decrease* buttons to make the physical reading match the timing number you selected.
- c) Note: This calibration needs to be properly tuned before driving the vehicle. It is intended for racing vehicles and may not operate smoothly at idle or part-throttle.  
**NEVER TUNE THE VEHICLE WHILE DRIVING**

#### 5) Troubleshooting an engine that will not start

- a) Double-check all the basics first... engines need air, fuel, compression, and a correctly-timed spark event. If any of these are lacking, we suggest checking simple things first. Depending on the symptoms, it may be best to inspect fuses, sufficient battery voltage, properly mated wiring connectors, spark using a timing light or by removing the spark plug, wiring continuity tests, measure ECU pinout voltages, replace recently-added or untested components with known-good spares. Check that all EMS sensor inputs measure realistic temperature and/or pressure values.
- b) If the EMS is not firing the coils or injectors at all, open the Start tab and look for the 'Stat Sync'd' channel to turn ON when cranking. This indicates that the EMS has detected the expected cam and crank signals; if Stat Sync'd does not turn on, monitor the Crank Tooth Period and T2PER channels which indicate the time between pulses on the Crank and T2 (Cam) signals. Both of these channels should respond when the engine is cranking, if either signal is not being detected or measuring an incorrect number of pulses per engine cycle the EMS will not fire the coils or injectors.
- c) If the Engine Load changes when the throttle is pressed this usually indicates that there is a problem with the MAP sensor wiring or software calibration (when the EMS detects that the MAP Volts are above or below the min/max limits it will run in a failsafe mode using the TPS-to-Load table to generate an artificial Engine Load signal using the Throttle input). This may allow the engine to sputter or start but not continue running properly.

# Application Notes for EMS P/N 30-6052

## 2000-2005 Honda S2000

Make:	Honda
Model:	S2000
Years Covered:	2000-2005
Engine Displacement:	2.0L or 2.2L (2004-2005)
Engine Configuration:	Inline 4
Firing Order:	1-3-4-2
N/A, S/C or T/C:	N/A
Load Sensor Type:	MAP
Map Min:	0.32V @ -13.9 PSI
Map Max:	4.84V @ 10.94 PSI
# Coils:	4 'smart' coils, built-in ignitors
EMS Ignition driver type:	0-5V, Falling Edge trigger
# Injectors:	4
Factory Injectors:	360cc/min Saturated
Factory Inj Resistors:	No
Injection Mode:	Sequential
Knock Sensors used:	1 (Knock #2)
Lambda Sensors used:	2 (aftermarket wideband: factory O2 not supported)
Idle Motor Type:	Duty-controlled solenoid
Main Relay Control:	No
Crank Pickup Type:	Magnetic (2-wire)
Crank Teeth/Cycle:	24
Cam Pickup Type:	Magnetic (2-wire)
Cam Teeth/Cycle:	3
Transmissions Offered:	M/T
Trans Supported:	M/T
Drive Options:	RWD
Supplied Connectors:	Plug D with spare pins
Plug-N-Pin kit:	AEM part# 35-2610 (includes plugs A-D, pins)

Spare Injector Drivers:	Inj 5, Pin D1
Spare Injector Drivers:	Inj 6, Pin B19
Spare Injector Drivers:	Inj 7, Pin D2
Spare Injector Drivers:	Inj 8, Pin B16
Spare Injector Drivers:	Inj 9, Pin A12/A13
Spare Injector Drivers:	Inj 10, Pin C11
Spare Injector Drivers:	Inj 11, Pin A14
Spare Injector Drivers:	Inj 12, Pin A10
Spare Coil Drivers:	Coil 7, Pin A13 **
Spare Coil Drivers:	Coil 8, Pin A22 **
Boost Solenoid:	PW #2, Pin D16
EGT #1 Location:	Pin A5
EGT #2 Location:	Pin D7
EGT #3 Location:	Pin A30
EGT #4 Location:	Pin C5
Spare 0-5V Channels:	ADCR03, Pin A29
Spare 0-5V Channels:	ADCR11, Pin C6
Spare 0-5V Channels:	ADCR13, Pin C24
Spare 0-5V Channels:	ADCR14, Pin D8
Spare Low Side Driver:	Low Side 1, Pin A2
Spare Low Side Driver:	Idle 2, Pin A28
Spare Low Side Driver:	Idle 4, Pin D5
Spare Low Side Driver:	Idle 6, Pin B17
Spare Low Side Driver:	Idle 8, Pin B25
Check Engine Light:	Low Side 10, Pin A18
Spare High Side Driver:	High Side 2, Pin B7
Spare High Side Driver:	High Side 4, Pin D4
Spare Switch Input:	Switch 1, Pin A32
Spare Switch Input:	Switch 2, Pin D11
Spare Switch Input:	Switch 3, Pin D12
Spare Switch Input:	Switch 5, Pin A26

**WARNING:** \*\*The Coil7 and Coil 8 outputs are intended only for use with ignitors (or smart coils with built-in ignitors). Do not connect these pins directly to 2-wire direct-fire ignition coils (a.k.a. 'dumb' coils); doing so will damage your EMS and void your warranty.

All switch input pins must connect to ground, the switch should not provide 12V power to the EMS because that will not be detected as on or off. Connecting 12V power to the switch input pins may damage your EMS and void your warranty.

The function of the following pins have been changed from the original 30-1052 EMS, please see pinout chart for more info:  
A1, A10, A11, A13, A14, A22, B24, D10, D14, D15

## OEM Engine Coolant Temperature Gauge (ECT) Functionality

Please note that the 30-6052 EMS is configured to drive the factory Honda ECT gauge by outputting the appropriate signal on pin A1. This signal is calibrated to use the OEM Honda engine coolant sensor; replacing the OEM sensor with one from a different vehicle may change the behavior of the gauge.

## Wiring accessories to the EMS:

Please follow this suggested wiring diagram when adding accessories such as UEGO gauges, Boost Control solenoids, or switches for use with the EMS. Note that wire polarity is not important for the Boost Control Solenoid.

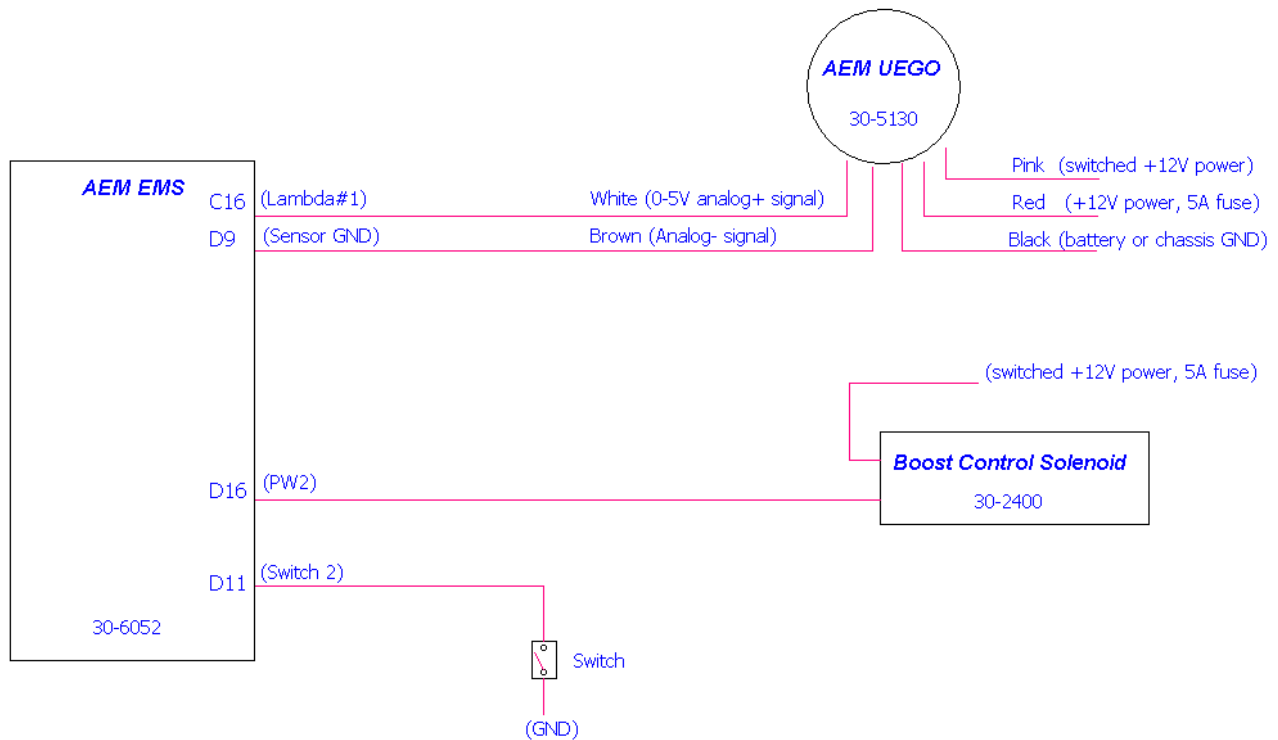

## Connection Diagram for EMS P/N 30-6052 2000-2005 Honda S2000

Pin #	2000-2005 S2000	AEM EMS 30-6052	I/O	Availability
A1	Engine Coolant Temp Gauge	Coolant dash signal	Output	Dedicated, works with AP1 and AP2
A2	Air Control Valve	Low Side Driver 1	Output	Avail, Switched Ground, 1.5A Max
A3	EVAP Bypass Solenoid Valve	Low Side Driver 3	Output	PnP For Bypass Solenoid
A4	EVAP Control Canister Vent	Low Side Driver 5	Output	PnP For Control Canister Vent
A5	---	EGT 1	Input	Avail, jumper set for 0-5V Input
A6	EVAP Purge Control Solenoid	Low Side Driver 4	Output	PnP For EVAP Purge Control
A7	---	Sensor Ground	Output	Avail, Sensor Ground
A8	---	Low Side Driver 12	Output	Avail, Switched Ground, 1.5A Max
A9	Vehicle Speed Sensor	T3 (Vehicle Speed)	Input	PnP for Vehicle Speed
A10	Service Check Signal	Injector 12	Output	Avail, Switched Ground, 1.5A Max
A11	---	PW3	Output	Avail, Switched Ground, 1.5A Max
A12	Immobilizer Indicator Light	Injector 9	Output	Avail, Switched Ground, 1.5A Max
A13	Immobilizer Enable Signal	Coil 7	Output	Avail, 0/5V falling edge signal
A14	---	Injector 11	Output	Avail, Switched Ground, 1.5A Max
A15	Fuel Pump Relay	Low Side Driver 11	Output	PnP for Fuel Pump Relay
A16	---	Low Side Driver 11	Output	**This pin connects to A15 also**
A17	A/C Clutch Relay	Low Side Driver 6	Output	PnP For A/C Clutch
A18	Malfunction Indicator Light	Low Side Driver 10	Output	PnP For MIL
A19	Engine Speed Pulse	Tach Output (LS7)	Output	PnP For Tach
A20	Radiator Fan Control	Low Side Driver 8	Output	PnP For Rad Fan Control
A21	K-Line	12VS	Output	Dedicated, filtered 12V power
A22	---	Coil 8	Output	Avail, 0/5V falling edge signal
A23	Secondary O2 Sensor	Lambda #2	Input	PnP For Lambda #2
A24	Starter Switch Signal	Cranking	Input	PnP For Starter Switch
A25	Immobilizer Code	Idle #3	Output	Avail, Switched Ground, 1.5A Max
A26	Electrical P/S Load Detect	Switch 5	Input	Avail, Switch must connect to ground
A27	A/C Switch Signal	Switch 6	Input	PnP For A/C Request
A28	Air Pump Relay	Idle #2	Output	PnP For Air Pump
A29	Fuel Tank Pressure Sensor	MAF	Input	Avail, 0-5V Input
A30	Electrical Load Detector	EGT #3	Input	Avail, jumper set for 0-5V Input
A31	---	Sensor Ground	Output	Avail, Sensor Ground
A32	Brake Switch Signal	Switch 1	Input	Avail, switch must connect to ground

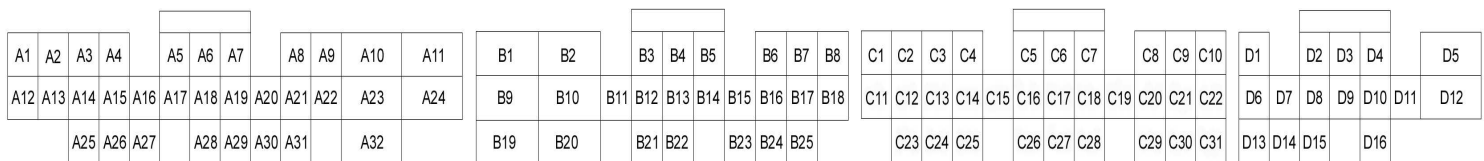

Connector A

Connector B

Connector C

Connector D

Pin #	2000-2005 S2000	AEM EMS 30-6052	I/O	Availability
B1	Power Source 1	+12V Switched	Both	Dedicated
B2	Power Ground 1	Power Ground	Both	Dedicated
B3	Injector 2	Injector 2	Output	PnP For Injector 2
B4	Injector 3	Injector 3	Output	PnP For Injector 3
B5	Injector 4	Injector 4	Output	PnP For Injector 4
B6	---	PW 1i	Output	PnP For Idle Control Solenoid
B7	---	High Side Driver 2	Output	Avail, Switched +12v, 1.5A Max
B8	---	Idle #5	Output	Avail, Switched Ground, 1.5A Max
B9	Power Source 2	+12V Switched	Both	Dedicated
B10	Power Ground 2	Power Ground	Both	Dedicated
B11	Injector 1	Injector 1	Output	PnP For Injector 1
B12	VTEC solenoid Valve	High Side Driver 1	Output	PnP For VTEC Solenoid
B13	---	Coil 1	Output	**This pin connects to C4 also**
B14	---	---	---	Not Used
B15	---	PW1	Output	**This pin connects to B23 also**
B16	---	Injector 8	Output	Avail, Switched Ground, 1.5A Max
B17	---	Idle #6	Output	Avail, Switched +12v, 1.5A Max
B18	---	Idle #7	Output	Avail, Switched Ground, 1.5A Max
B19	---	Injector 6	Output	Avail, Switched Ground, 1.5A Max
B20	Logic Ground 1	Power Ground	Both	Dedicated
B21	Voltage Back Up	Permanent +12V	Input	PnP For Perm Power
B22	Logic Ground 2	Power Ground	Both	Dedicated
B23	Idle Air Control Valve	PW1	Output	PnP For Idle Control Solenoid
B24	---	Knock 2	Input	Available, software knock filter
B25	---	Idle #8	Output	Avail, Switched +12v, 1.5A Max

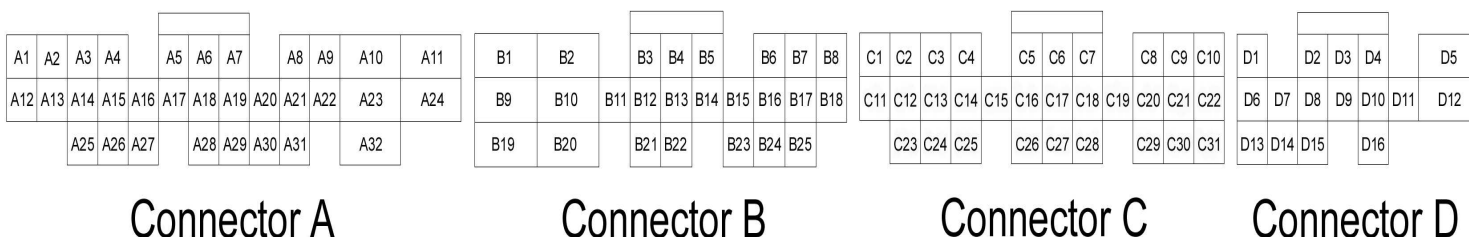



Pin #	2000-2005 S2000	AEM EMS 30-6052	I/O	Availability
C1	Primary O2 Heater Control	Low Side Driver 2	Output	Avail, Switched Ground, 1.5A Max
C2	Alternator Control	---	---	Not Used
C3	---	Knock 1	Input	PnP For Knock 1
C4	Ignition Coil Pulse No. 1	Coil 1	Output	PnP Coil 1, 0/5V falling edge trigger
C5	Alternator FR Signal	EGT #4	Input	Avail, jumper set for 0-5V Input
C6	---	ADCR11	Input	Available, 0-5V in
C7	Sensor Ground 1	Sensor Ground	Output	Dedicated, Sensors only
C8	CKP +	Crank Sensor	Input	PnP For Crank Sensor
C9	CKP -	Timing Ground	Output	PnP For Timing Ground
C10	VTEC Pressure Switch Signal	Switch 4	Input	PnP For VTEC Oil Press Sw
C11	Secondary O2 Heater Control	Injector 10	Output	Avail, Switched Ground, 1.5A Max
C12	Ignition Coil Pulse No. 2	Coil 2	Output	PnP Coil 2, 0/5V falling edge trigger
C13	Ignition Coil Pulse No. 3	Coil 3	Output	PnP Coil 3, 0/5V falling edge trigger
C14	Ignition Coil Pulse No. 4	Coil 4	Output	PnP Coil 4, 0/5V falling edge trigger
C15	Secondary O2 Sensor	Lambda 2	Input	Avail, 0-5v Lambda 2 input
C16	Primary O2 Sensor	Lambda 1	Input	Avail, 0-5v Lambda 1 input
C17	MAP Sensor	MAP	Input	PnP For 0-5v MAP Sensor
C18	Sensor Ground 2	Sensor Ground	Output	Dedicated, Sensors only
C19	Sensor Voltage 1	+5V Sensor	Output	Dedicated, Sensors only
C20	TDC1 +	Cam	Input	Dedicated, Cam Sensor
C21	TDC1 -	Timing Ground	Output	PnP, Cam Sensor Ground
C22	Knock Sensor	Knock #2	Input	Avail, Knock Sensor
C23	---	T3 (Vehicle Speed)	Input	PnP Vehicle Speed Sensor
C24	Air Pump Electric Current Sensor	ADCR13	Input	Available, 0-5V in, 100k pull up to 5v
C25	Intake Air Temp Sensor	AIT	Input	PnP AIT Sensor
C26	Engine Coolant Temp Sensor	Coolant	Input	PnP ECT Sensor
C27	Throttle Position Sensor	TPS	Input	PnP TPS Sensor
C28	Sensor Voltage 2	+5V Sensor	Output	PnP Sensor Vcc
C29	TDC2 +	T4 (Spare Speed)	Input	Avail, Spare Speed Sensor
C30	TDC2 -	Timing Ground	Output	Dedicated
C31	---	Timing Ground	Output	Dedicated

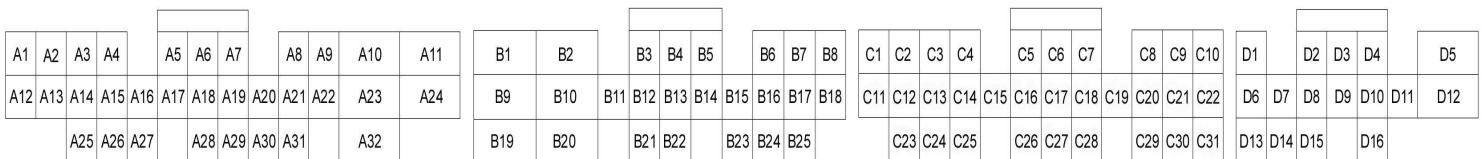

Connector A

Connector B

Connector C

Connector D

Pin #	2000-2005 S2000	AEM EMS 30-6052	I/O	Availability
D1	---	Injector 5	Output	Avail, Switched Ground, 1.5A Max
D2	---	Injector 7	Output	Avail, Switched Ground, 1.5A Max
D3	---	Idle #1	Output	Avail, Switched Ground, 1.5A Max
D4	---	High Side Driver 4	Output	Avail, Switched +12v, 1.5A Max
D5	---	Idle #4	Output	Avail, Switched +12v, 1.5A Max
D6	---	+5V Sensor	Output	Avail, 5V sensor reference power
D7	---	EGT #2	Input	Avail, jumper set for 0-5V Input
D8	---	ADCR14	Input	Available, 0-5V in, 100k pull up to 5v
D9	---	Sensor Ground	Output	Avail, Sensor Ground
D10	---	CAN1H	---	Dedicated
D11	---	Switch 2	Input	Avail, Switched GND Input
D12	---	Switch 3	Input	Avail, Switched GND Input
D13	---	High Side Driver 3	Output	Avail, Switched +12v, 1.5A Max
D14	---	CAN1L	---	Dedicated
D15	---	Baro Volts	---	Avail, 0-5V input
D16	---	PW 2	Output	Avail, Boost Solenoid Output

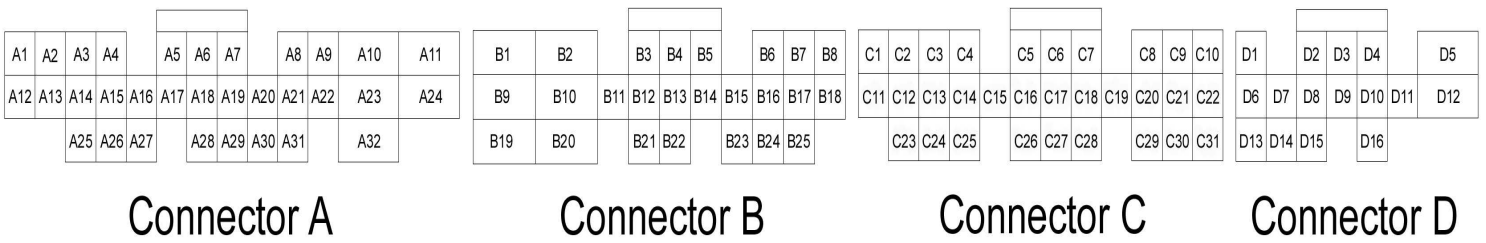

## **AEM Electronics Warranty**

Advanced Engine Management Inc. warrants to the consumer that all AEM Electronics products will be free from defects in material and workmanship for a period of twelve months from date of the original purchase. Products that fail within this 12-month warranty period will be repaired or replaced when determined by AEM that the product failed due to defects in material or workmanship. This warranty is limited to the repair or replacement of the AEM part. In no event shall this warranty exceed the original purchase price of the AEM part nor shall AEM be responsible for special, incidental or consequential damages or cost incurred due to the failure of this product. Warranty claims to AEM must be transportation prepaid and accompanied with dated proof of purchase. This warranty applies only to the original purchaser of product and is non-transferable. All implied warranties shall be limited in duration to the said 12-month warranty period. Improper use or installation, accident, abuse, unauthorized repairs or alterations voids this warranty. AEM disclaims any liability for consequential damages due to breach of any written or implied warranty on all products manufactured by AEM. Warranty returns will only be accepted by AEM when accompanied by a valid Return Merchandise Authorization (RMA) number. Product must be received by AEM within 30 days of the date the RMA is issued.

Please note that before AEM can issue an RMA for any electronic product, it is first necessary for the installer or end user to contact the tech line at 1-800-423-0046 to discuss the problem. Most issues can be resolved over the phone. Under no circumstances should a system be returned or a RMA requested before the above process transpires.

AEM will not be responsible for electronic products that are installed incorrectly, installed in a non approved application, misused, or tampered with.

Any AEM electronics product can be returned for repair if it is out of the warranty period. There is a minimum charge of \$50.00 for inspection and diagnosis of AEM electronic parts. Parts used in the repair of AEM electronic components will be extra. AEM will provide an estimate of repairs and receive written or electronic authorization before repairs are made to the product.